



Online UPS

UPO22 6/10 RT

Uninterruptible Power Supply System



Please comply with all warnings and operating instructions in this manual strictly. Save this manual properly and read carefully the following instructions before installing the unit. Do not operate this unit before reading through all safety information and operating instructions carefully.

Table of Contents

1. SAFETY WARNINGS AND EMC INSTRUCTIONS	3
1-1. UPS LOCATION WARNINGS	3
1-2. CONNECTION WARNINGS	3
1-3. MAINTENANCE WARNINGS	4
1-4. BATTERY WARNINGS	5
1-5. STANDARDS	5
2. INSTALLATION	6
2-1. UNPACKING AND INSPECTION	6
2-2. REAR PANEL VIEW	6
2-3. SYSTEM SINGLE LINE DIAGRAM	9
2-4. RACK/TOWER INSTALLATION	9
2-5. SINGLE UPS INSTALLATION	11
2-6. PARALLEL UPS INSTALLATION	13
3. OPERATIONS	16
3-1. OPERATING MODE/STATUS DESCRIPTION	16
3-2. BUTTON OPERATION	16
3-3. LED INDICATORS	17
3-4. AUDIBLE ALARM	17
3-5. SINGLE UPS OPERATION	17
3-6. PARALLEL UPS OPERATION	20
3-7. LCD OPERATION	20
3-7-1. MAIN INTERFACE (HOME PAGE)	21
3-7-2. OPERATION MENU	21
3-7-2-1. MAIN MENU	21
3-7-2-2. CONTROL ITEMS	22
3-7-2-3 · MEASUREMENT PAGES	24
3-7-2-4 · INFORMATION PAGES	24
3-7-2-5. SETTING MENU	25
3-7-2-6. ALARM PAGE	29
4. TROUBLE SHOOTING	30
4-1. WARNING STATUS	30
4-2. FAULT MODE	30
4-3. TROUBLE SHOOTING TABLE	30
5. STORAGE	32
6. SPECIFICATIONS	33

1. Safety Warnings and EMC instructions

⚠ CAUTION: Before performing the procedures in this document, read and follow the safety instructions and important regulatory information in your **Safety, Environmental, and Regulatory Information** document.

This manual contains important instructions that you should follow during installation and maintenance of the UPS and batteries. Please read all instructions before operating the equipment and save this manual for future reference.

⚠ 1-1. UPS Location Warnings

- Install your UPS indoors, away from excess moisture or heat, direct sunlight, dust and conductive contaminants.
- Install your UPS in a structurally sound area. Your UPS is extremely heavy; take care when moving and lifting the unit.
- Only operate your UPS at indoor temperatures between 32° F and 104° F (between 0° C and 40° C).
- Leave adequate space around all sides of the UPS for proper ventilation.
- Do not install the UPS near magnetic storage media, as this may result in data corruption.
- Do not mount unit with its front or rear panel facing down (at any angle). Mounting in this manner will seriously inhibit the unit's internal cooling, eventually causing product damage not covered under warranty.

⚠ 1-2. Connection Warnings

- There is no standard feedback protection inside, please isolate the UPS before working according to this circuit.

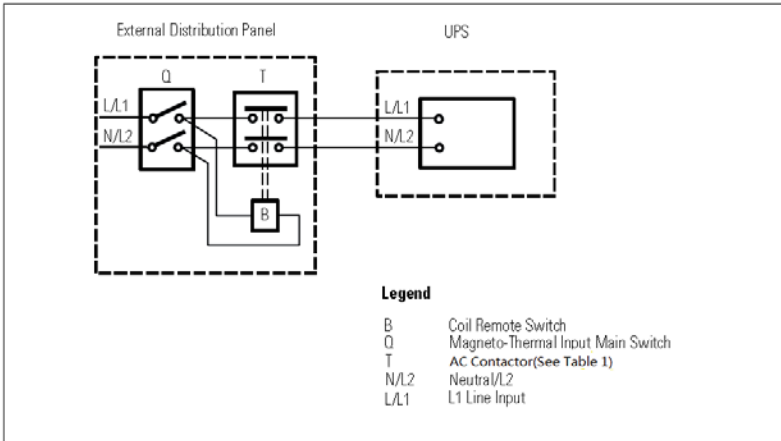

The following table lists AC contactor that can be used as back feed protection devices.

Table 1:

Module type	Manufacturer	Type	Rating
6K	Tianshui 213 Electrical Apparatus Co.,Ltd	GSC1(CJX4-d)-4011	220Vac,40A
	LS Industrial systems Co.,Ltd.	GMC(D)-32	600Vac,45A
10K	Tianshui 213 Electrical Apparatus Co.,Ltd	GSC1(CJX4-d)-6511	220Vac,65A

- This UPS should be connected with **TN** earthing system
- The power supply for this unit must be single-phase rated in accordance with the equipment nameplate. It also must be suitably grounded
- Use of this equipment in life support applications where failure of this equipment can reasonably be expected to cause the failure of the life support equipment or to significantly affect its safety or effectiveness is not recommended. Do not use this equipment in the presence of a flammable anesthetic mixture with air, oxygen or nitrous oxide.
- Connect your UPS power module's grounding terminal to a grounding electrode conductor.
- The UPS is connected to a DC energy source (battery). The output terminals may be live when the UPS is not connected to an AC supply.

1-3. Maintenance Warnings

- Service and repair should be done only by trained personnel. During any service work to the UPS, it should be turned off or manually bypassed. Note that potentially lethal voltages exist within this unit as long as the battery supply is connected.
- Your UPS power module and battery module(s) do not require routine maintenance. Do not open them for any reason. There are no user-serviceable parts inside.
- Even after the unit is disconnected from the mains, components inside the UPS system are still connected to the battery packs which are potentially dangerous.
- Before carrying out any kind of service and/or maintenance, disconnect the batteries and verify that no current is present and no hazardous voltage exists in the terminals of high capacity capacitor such as BUS-capacitors.
- Fuses should be replaced only by factory authorized personnel. Blown fuses should be replaced only with fuses of the same number and type.
- Verify that no voltage between the battery terminals and the ground is present before maintenance or repair. In this product, the battery circuit is not isolated from the input voltage. Hazardous voltages may occur between the battery terminals and the ground.



1-4. Battery Warnings

- Do not operate your UPS without connecting it to an external battery module.
- Batteries can present a risk of electrical shock and burn from high short-circuit current. Observe proper precautions.
 - a) Remove watches, rings, or other metal objects
 - b) Use tools with insulated handles.
 - c) Wear rubber gloves and boots.
 - d) Do not lay tools or metal parts on top of batteries.
 - e) Disconnect charging source prior to connecting or disconnecting battery terminals.
- Do not dispose of the batteries in a fire. Do not open the UPS or batteries. The batteries must be rightly deposited according to local regulation.
- Do not short or bridge the battery terminals with any object.
- Unplug and turn off the UPS before performing battery replacement.
- Battery replacement should be performed only by authorized service personnel using the same number and type of batteries (Sealed Lead-Acid). Use tools with insulated handles. The batteries are recyclable.
- Do not open or mutilate the batteries. Released electrolyte is harmful to the skin and eyes, and may be toxic.
- Do not connect or disconnect battery module(s) while the UPS is operating from the battery supply.

1-5. Standards

* Safety	
Safety Conformance: IEC/EN 62040-1,UL1778 (4th Edition)	
Safety Markings : TUV, cTUVus, CE	
* EMI	
Conducted Emission.....:IEC/EN 62040-2	Category C3
Radiated Emission.....:IEC/EN 62040-2	Category C3
*EMS	
ESD.....:IEC/EN 61000-4-2	Level 4
RS.....:IEC/EN 61000-4-3	Level 3
EFT.....:IEC/EN 61000-4-4	Level 4
SURGE.....:IEC/EN 61000-4-5	Level 4
CS.....:IEC/EN 61000-4-6	Level 3
Power-frequency Magnetic field.....:IEC/EN 61000-4-8	Level 4
Low Frequency Signals.....:IEC/EN 61000-2-2	
Warning: This is a product for commercial and industrial application in the second environment-installation restrictions or additional measures may be needed to prevent disturbances.	

2. Installation

There are two types: standard and long-run models. Please refer to the following model table.

Model	Type	Model	Type
6KRT	Standard model	6KRTL	Long-run model
10KRT	Standard model	10KRTL	Long-run model

2-1. Unpacking and Inspection

Unpack the package and check the package contents. The shipping package contains:

- One UPS
- One user manual
- One monitoring software CD
- One RS-232 cable (option)
- One USB cable
- One parallel cable and one share current cable (option)
- One battery cable (option)
- Two sets of tower stands including feet and extensions
- Rack-mounting ears
- Battery cable connection ears
- Sixteen M4 screws and four metal plates (only for UPS with ISO Bank)

NOTE: Before installation, please inspect the unit. Be sure that nothing inside the package is damaged during transportation. Do not turn on the unit and notify the carrier and dealer immediately if there is any damage or lacking of some parts. Please keep the original package in a safe place for future use.

NOTE: In this manual, isolation transformer unit will simply be referred to as ISO Bank.

2-2. Rear Panel View

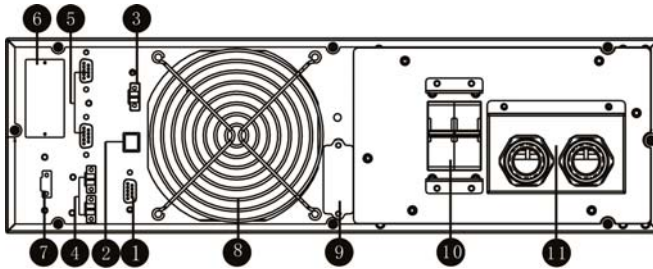

Diagram 1: 6KRT(L)/10KRT(L) Rear Panel

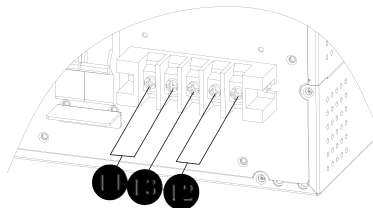

Diagram 2: 6KRT(L)/10KRT(L) Input/Output Terminal

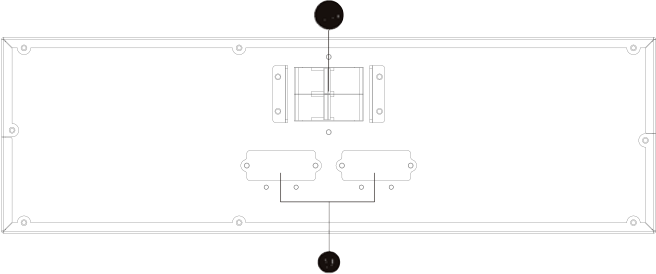

Diagram 3: Battery Pack Rear Panel

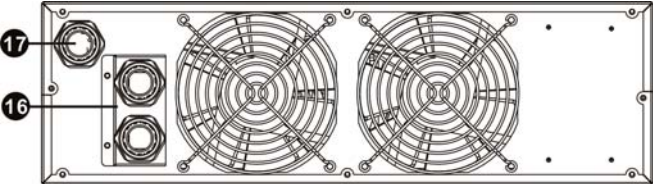

Diagram 4: ISO Bank Rear Panel Overlook

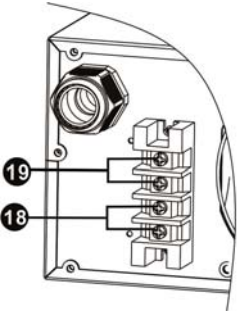

Diagram 5: ISO Bank Output Terminal

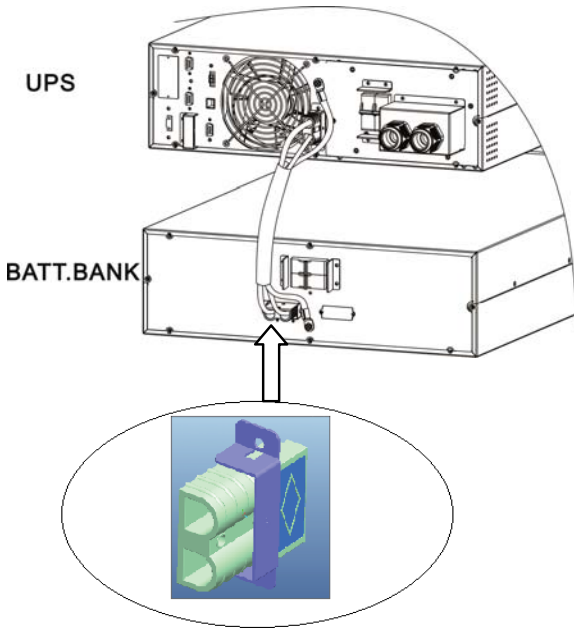
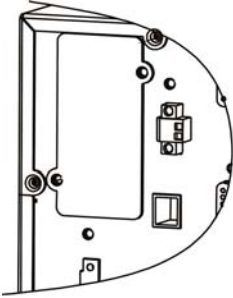

Diagram 6: Connection between Battery Pack and UPS

1. RS-232 communication port
2. USB communication port
3. EPO (Emergency Power Off) connector
4. Share current port (for parallel function)
5. Parallel port (for parallel function)
6. Intelligent slot
7. EMBS (External Maintain Bypass Switch) port
8. Cooling fan
9. External battery connector
10. Input circuit breaker
11. Input/Output terminal
12. Input terminal
13. Ground
14. Output terminal
15. Battery pack output circuit breaker
16. ISO bank output terminal (Refer to Diagram 5 for the details)
17. ISO BANK INPUT
18. ISO BANK OUTPUT 1
19. ISO BANK OUTPUT 2

Installation

Note: Keep the EPO connector closed for UPS normal operation. To activate EPO function, please remove the jumper.



It's in closed status for UPS normal operation.



WARNING: The EPO, RS-232 and USB circuits are IEC 60950 safety extra low voltage (SELV) circuits. This circuit must be separated from any hazardous voltage circuits by reinforced insulation.

2-3. System single line diagram

System single line diagram is demonstrated as picture below:

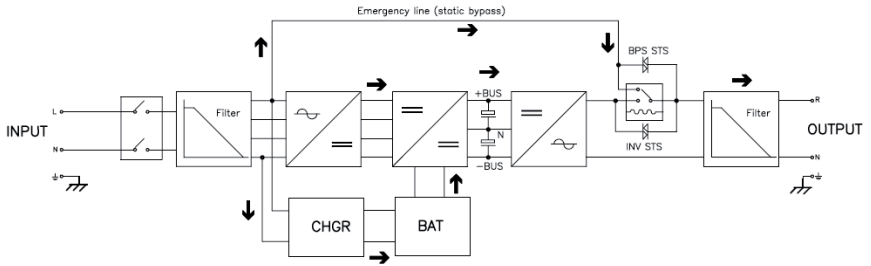

2-4. Rack/Tower installation

2-4-1 Tower Installation

The UPS system is shipped with four plastic feet and 6 plastic extensions (2 short extension plus 4 long extensions). Those can be used to tower install the UPS power module in 3U or UPS power module with one battery bank in 6U.

1. To 3U module, it's not necessary to use long extensions. Assemble two feet and one short extension together as one supporter with 13cm width available. Another supporter could be assembled in same method.
2. To 6U module, it's not necessary to use short extensions. Assemble two feet and two long extensions together. Then, one set of plastic supporter with 26cm width is done. Another set of supporter could be

assembled in same way.

3. Align the two supporters in your installation area, appropriately 35cm apart.
4. Then, simply put UPS module and battery bank in the stands as shown in step 3. Be sure that the LCD of UPS should be on upper half part of front panel.
5. If this UPS is with ISO bank, assemble these metal plates and M4 screws as shown in step 4.

Step 1

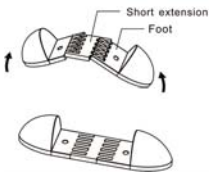

Step 2

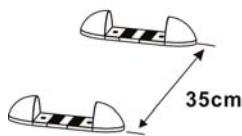

Step 3

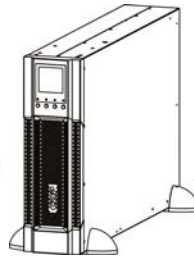

3U Tower

Step 1

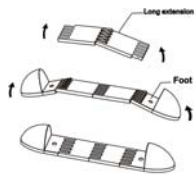

Step 2



Step 3

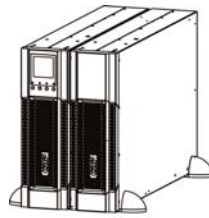

Step 4:

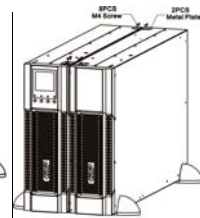

6U Tower

2-4-2 Rack Installation

1. Attach mounting ears to the side mounting holes of UPS using the screws provided and the ears should face forward.
2. Lift the UPS module and slide it onto the mounting shelves. Attach the UPS module to the rack with the screws, nuts and washers (user-provided) through its mounting ears and into the rack rails.

Step 1

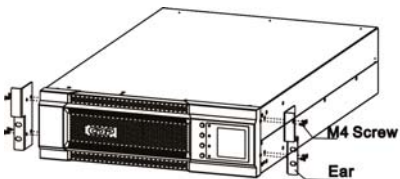

Step 2

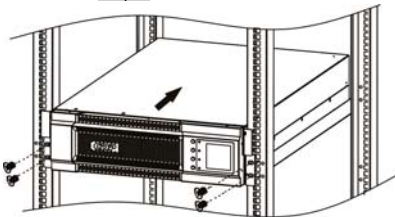

2-5. Single UPS Installation

Installation and wiring must be performed in accordance with the local electric laws/regulations and execute the following instructions by professional personnel.

1) Make sure the mains wire and breakers in the building are enough for the rated capacity of UPS to avoid the hazards of electric shock or fire.

NOTE: Do not use the wall receptacle as the input power source for the UPS, as its rated current is less than the UPS's maximum input current. Otherwise the receptacle may be burned and destroyed.

2) Switch off the mains switch in the building before installation.

3) Turn off all the connected devices before connecting to the UPS.

4) Prepare wires based on the following table:

Model	Wiring spec (AWG)			
	Input	Output	Battery	Ground
6KRT(L)	8	8	10	8
10KRT(L)	6	6	8	6
6KRT-ISO(L)	10	10	10	10
10KRT-ISO(L)	8	8	8	8

NOTE 1: The cable for 6KRT(L)/6KRT-ISO(L) should be able to withstand over 40A current. It is recommended to use 8AWG or thicker wire for safety and efficiency.

NOTE 2: The cable for 10KRT(L)/10KRT-ISO(L) should be able to withstand over 63A current. It is recommended to use 6AWG or thicker wire for safety and efficiency.

NOTE 3: The selections for color of wires should be followed by the local electrical laws and regulations.

NOTE 4: External battery wires must use reinforced insulation or double insulated wire.

5) Remove the terminal block cover on the rear panel of UPS (only available for UPS with ISO Bank). Then, connect the wires according to the following diagrams:

Connect the earth ground wire first when making wire connection. Disconnect the earth ground wire last when making wire disconnection!

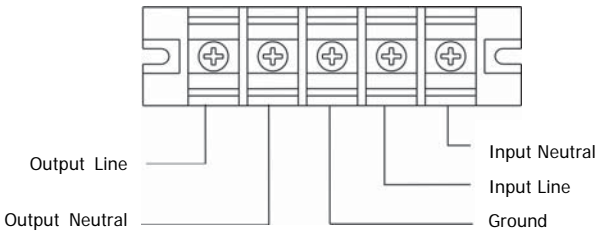

Terminal block wiring diagram of UPS

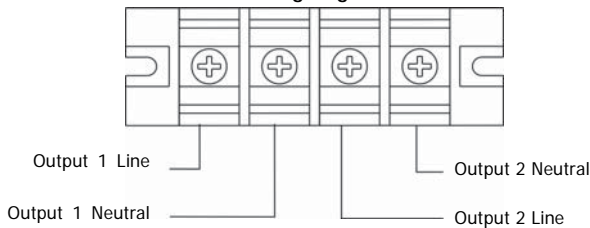

Terminal block wiring diagram of 6KL/10KL ISO BANK

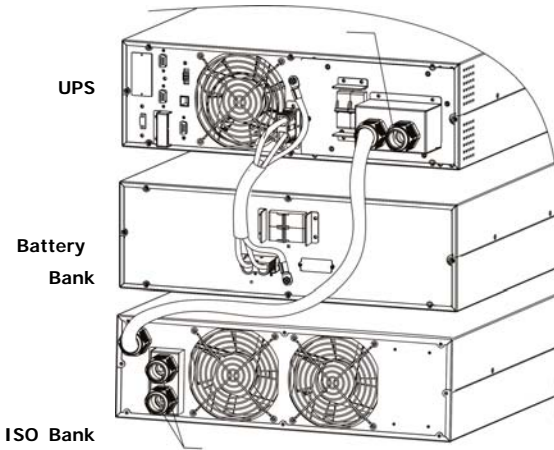

System Connection Overview

NOTE 1: Make sure that the wires are connected tightly with the terminals.

NOTE 2: Please install the output breaker between the output terminal and the load. The breaker should be qualified with leakage current protective function if necessary.

6) Put the terminal block cover back to the rear panel of the UPS.



Warning:

- For standard battery bank, there are one DC breaker to disconnect the battery bank and the UPS. But for other external battery bank, make sure a DC breaker or other protection device between UPS and external battery bank is installed. If not, please install it carefully. Switch off the battery breaker before installation.

NOTE: Set the battery bank breaker in "OFF" position and then install the battery bank.

- Pay highly attention to the rated battery voltage marked on the rear panel. If you want to change the numbers of the battery bank, please make sure you modify the setting simultaneously. The connection with wrong battery voltage may cause permanent damage of the UPS. Make sure the voltage of the battery bank is correct.
- Pay highly attention to the polarity marking on external battery connector and make sure the correct battery polarity is connected. Wrong connection may cause permanent damage of the UPS.
- Make sure the protective earth ground wiring is correct. The wire current spec, color, position, connection and conductance reliability should be checked carefully.
- Make sure the utility input & output wiring is correct. The wire current spec, color, position, connection and conductance reliability should be checked carefully. Make sure the L/N site is correct, not reverse and short-circuited.

2-6. Output Configuration

Output of the UPS should be connected to the input of ISO bank and the output of ISO bank is the final output of system.

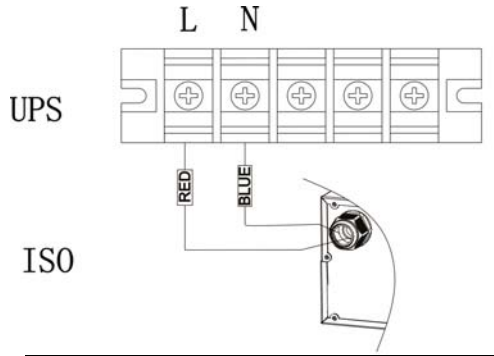

Output of the UPS connects to the input of ISO bank

★ Option 1:

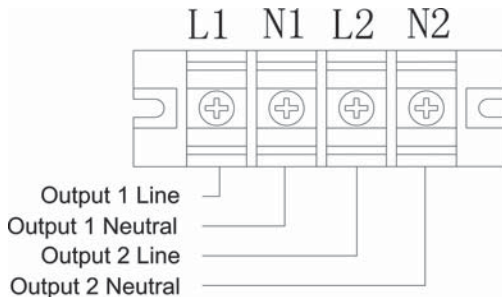

The output wiring of ISO bank

There are 2 sets of low-voltage outputs (104/110/115/120V) on L1-N1 & L2-N2. Each set is able to provide 50% of UPS rating power. Connect one load to L1-N1 and the other load to L2-N2.

★ Option 2:

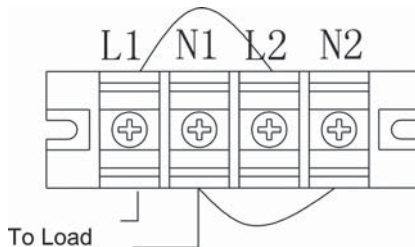

The output wiring of ISO bank

After connecting L1&L2 and N1&N2, it becomes one low-voltage output (104/110/115/120V) at L1-N1 for 100% of UPS rating power. Connect load to L1-N1 or L2-N2.

★ **Option 3:**

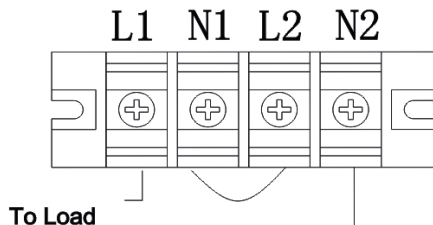

The output wiring of ISO bank

After connecting N1 and L2, it becomes one high-voltage output (208/220/230/240V) at L1-N2 for 100% of UPS rating power. Connect load to L1-N2.

★ **Option 4:**

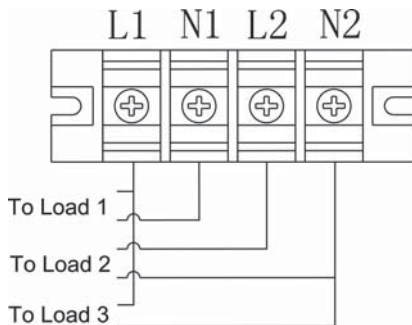

The output wiring of ISO bank

After connecting N1&L2, it becomes three outputs, one high-voltage output (208/220/230/240V) at L1-N2 and two low-voltage outputs (104/110/115/120V) at L1-N1 & L2-N2. However, there is a limit for current rating at L1-N1 & L2-N2: 25A for 6K(L) model and 42A at 10K(L) model. You must connect the load under the limitation. Please read Note first before installation.

Connect low-voltage load to L1-N1 and L2-N2, and connect high-voltage load to L1-N2.

NOTE 1: If any load current in L1-N1 or L2-N2 is higher than 25A in 6K(L) model and 42A in 10K(L) model, the UPS will still operate normally without overload warning because the total load is under the specification. However, the isolation transformer will be damaged with overheat due to high current. Hence, the installation must be done with technician and make sure that the load current does not exceed this limitation.

NOTE 2: When connecting to low-voltage and high-voltage at the same time like option 4, it will cause the L1-N1 & L2-N2 with low-voltage loads in Non-Isolated status because high-voltage is generated by shorting N1-L2. If it's required to keep connected load in isolated status, we recommend that you may only use two low-voltages at L1-N1 or L2-N2 like option 1, and also make sure that the total current in L1-N1 or L2-N2 does not exceed the value on Note 1.

2.7. Parallel UPS Installation

For parallel UPS installation, please contact your dealer for more professional support.

3. Operations

3-1. Operating Mode/Status Description

Mode/Status	
UPS power on	When UPS is powered on, it will enter into this mode for a few seconds for initializing the CPU and system.
Line Mode	When the input voltage is within acceptable range, and the UPS is turned on (the inverter is running), the UPS will provide pure and stable sine wave AC voltage. The UPS will also charge the battery in Line mode.
ECO Mode	When the input voltage is within voltage regulation range and "ECO" mode is enabled, the UPS will bypass voltage to output for energy saving. If the input voltage is out of the regulation range but it is still within acceptable range of Line mode, the UPS will transfer to inverter supplying the power to load (similar as Line mode).
Converter Mode	When input frequency is within 46 to 64Hz, the UPS can be set with a constant output frequency (50 Hz or 60 Hz) through the inverter. The UPS will still charge battery at this mode. There is no bypass at this mode.
Battery Mode	When the input voltage is out of the acceptable range or power failure, and the UPS is turned on (the inverter is running), the UPS will backup power from battery.
Bypass Mode	When input voltage is within acceptable range and bypass is enabled, and the UPS (inverter) is not turned on or the inverter can't support the load, the UPS will supply power to the load through bypass.
Battery Test Mode	When the UPS is in Line mode or Converter mode, and the battery test command is enabled through LCD or monitoring software, the UPS will start Battery Test. This operation is used to check the battery status.
Warning Status	If some errors occur in the UPS (but it is still running normally), buzzer will alarm and warning code will appear in the LCD for trouble shooting.
Fault Mode	When fatal error occurs in the UPS, it will beep continuously and go to fault mode. It will display fault codes in LCD.

3-2. Button Operation

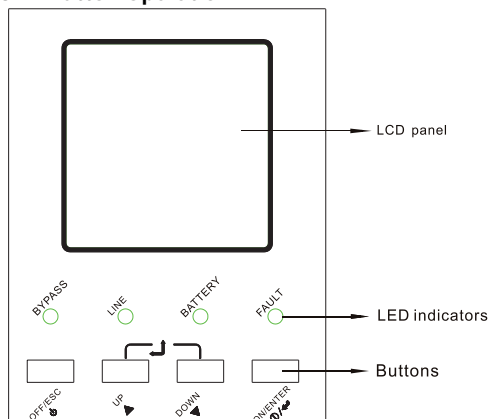

There are 4 buttons on front panel.

Button	Function
ON/ENTER	<ul style="list-style-type: none"> ➤ Press this button to turn on the UPS. ➤ Or press it to confirm the selection in the menu.
OFF/ESC	<ul style="list-style-type: none"> ➤ Press this button to turn off the UPS. ➤ Or press it to return to last menu.
UP*	<ul style="list-style-type: none"> ➤ Press this button to select the previous item in the menu. ➤ Or press this button to jump to previous page in the screen. ➤ Or press this button to increase the number in the setting.
DOWN*	<ul style="list-style-type: none"> ➤ Press this button to select the next item in the menu. ➤ Or press this button to jump to next page in the screen. ➤ Or press this button to decrease the number in the setting.

*If pressing UP and DOWN button together, the LCD display will rotate 90° automatically. This operation is used when configuring the UPS to Rack or Tower display.

3-3. LED Indicators

There are 4 LEDs on front panel to show the UPS working status:

Mode \ LED	Bypass	Line	Battery	Fault
UPS power on	●	●	●	●
Bypass mode	●	○	○	○
Line mode / Converter mode	○	●	○	○
Battery mode	○	○	●	○
Fault mode	○	○	○	●
Battery test mode	○	●	●	○
ECO mode	●	●	○	○

Note: ● means LED is lit; ○ means LED is faded; ● means LED is flashing.

3-4. Audible alarm

UPS status	Buzzer status	Muted
Bypass mode	Beeping once every 2 minutes	Yes
Battery / Battery-test mode (normal battery voltage)	Beeping once every 4 seconds	Yes
Battery / Battery-test mode (low battery voltage)	Beeping once every second	Yes
Fault	Beeping continuously	Yes
Warnings (except overload)	Beeping once every second	No
Overload	Beeping twice every second	No
Others	Mute	-

3-5. Single UPS Operation

3-5-1. Turn on the UPS with utility power supply (to Line mode)

- 1) Make sure mains input and battery are connected well, and the battery pack breaker is at "ON" position; Set the external mains input breaker to "ON" position, then the fan will be running and the UPS supplies power to the loads via bypass; (The UPS is operating in Bypass mode.)

NOTE: When UPS is in Bypass mode, the output voltage comes directly from utility, so the load is not protected by UPS. To protect the precious load, the UPS should be turned on to Line mode.

- 2) When LCD is on home page, press the "ON/ENTER" button, LCD will show a prompt page of "Turn On"; Move the arrow to "Yes" by up or down button, then press "ON/ENTER", the UPS will be starting up with beeping once. You could also enter the "control menu" to select the instruction "Turn On" to startup the UPS. Please refer to the section of "LCD operation".
- 3) A few seconds later, the UPS will enter into Line mode; "Line mode" will be displayed on LCD. (In

line mode, if the utility power is abnormal, the UPS will transfer to Battery mode without interruption.)

3-5-2. Turn on the UPS without utility power supply (to Battery mode)

- 1) Make sure the battery is connected well and the battery pack breaker is at "ON" position;
- 2) Press the "ON/ENTER" button to start up the internal power, the UPS will enter into bypass mode without output;
- 3) When LCD is on home page, press the "ON/ENTER" button, LCD will show a prompt page of "Turn On"; Move the arrow to "Yes" by up or down button, then press "ON/ENTER", the UPS will be starting up with beeping once. You could also enter the "control menu" to select the instruction "Turn On" to startup the UPS. Please refer to the section of "LCD operation".
- 4) A few seconds later, the UPS will enter into Battery mode; "Battery mode" will be displayed on LCD (In Battery mode, it will shutdown automatically when battery is depleted. If the utility power is restored, it will auto restart to Line mode.)

3-5-3. Connect devices to UPS

After the UPS is turned on, you can connect devices (load) to the UPS.

- 1) Turn on the UPS first and then switch on the devices one by one, the LCD panel will display total load level;
- 2) If inductive loads needed to be connected, such as a printer, the in-rush current should be calculated carefully to see if capacity of the UPS can cover due to the huge starting power consumption of this kind of load;
- 3) If the UPS is overload, the buzzer will beep twice every second;
- 4) When the UPS is overload, please remove some loads immediately. It is recommended to have the total loads connected to the UPS less than 80% of its nominal power capacity for system safety;
- 5) If the overload time is over duration listed in spec at Line mode, the UPS will automatically transfer to Bypass mode. After the overload is removed, it will return to Line mode. If the overload time is over duration listed in spec at Battery mode, the UPS will become fault status. At this time, if bypass is enabled, the UPS will power to the load via bypass. If bypass function is disabled or the input power is not within bypass acceptable range, it will cut off output directly.

3-5-4. Charge the batteries

- 1) After the UPS is connected to the utility power, the charger will charge the batteries automatically except in Battery mode or during battery test;
- 2) Suggest to charge batteries at least 10 hours before use. Otherwise, the backup time may be shorter than expected;
- 3) Make sure the battery numbers setting on the control board (Please refer to the section of changing battery quantity) is consistent with actual connection.

3-5-5. Battery mode operation

- 1) When the UPS is in Battery mode, the buzzer will beep according to different battery capacity. Normally, the buzzer will beep once every 4 seconds in battery mode, but when the battery voltage drops to the alarm level, the buzzer will beep once per second and the UPS will shut down automatically soon. Users could switch off some non-critical loads to disable the shutdown alarm and prolong the backup time. If there is no more load to be taken off at that time, you have to shut down all loads as soon as possible to protect the devices or save data. Otherwise, there is a risk of data loss or load failure;

- 2) In Battery mode, if buzzer sounds annoying, you could enter "Control->Mute" on LCD to silence it. Please refer to the section of "LCD operation";
- 3) The backup time of the long-run model depends on the external battery capacity;
- 4) The backup time may change under different environment temperature and load type;
- 5) The maximum backup time is limited by default 16.5 hours (After discharging 16.5 hours, UPS will shut down automatically to protect the battery). The time could be modified through LCD panel or communication port.

3-5-6. Test the batteries

- 1) If you need to check the battery status or performance when the UPS is running in Line / Converter / ECO mode, you could enter "Control->Batt Test" to instruct the UPS to do battery test. Please refer to the section of "LCD operation";
- 2) Users also can set battery test through monitoring software;
- 3) If the UPS is in battery testing, "Battery test mode" will be displayed on LCD, the buzzer indication will be the same as Battery mode, but both line LED and battery LED will be lit.

3-5-7. Turn off the UPS with utility power supply in Line mode

- 1) When LCD is on home page, press the "OFF/ESC" button, LCD will show a prompt page of "Turn Off"; Move the arrow to "Yes" by up or down button, then press "ON/ENTER", the UPS will be turning off to bypass mode with beeping once. You could also enter the "control menu" to select the instruction "Turn Off" to turn off the UPS. Please refer to the section of "LCD operation";

NOTE: Here, "Turn Off" means that UPS is not working on line / converter / ECO / battery / battery test mode. So even though the UPS is turned off, if input or bypass voltage is normal, the internal power supply will be still working; and if bypass status has been set to "enable", the output voltage of the UPS will be still exist;

- 2) If you need to fully cut off the output, please switch off the external input breaker. A few seconds later, there is no display shown on the panel and UPS is completely off.

3-5-8. Turn off the UPS without utility power supply in Battery mode

- 1) When LCD is on home page, press the "OFF/ESC" button, LCD will show a prompt page of "Turn Off"; Move the arrow to "Yes" by up or down button, then press "ON/ENTER", the UPS will be turning off to bypass mode with beeping once. You could also enter the "control menu" to select the instruction "Turn Off" to turn off the UPS. Please refer to the section of "LCD operation";
- 2) If there is no bypass input voltage, the UPS will cut off all power supply and there is no display shown on the panel.

3-5-9. Changing battery quantity (number)

The default battery (12V) quantity of this UPS system is 20 (for one series), but 18, 19 could also be applied in this system. However, before changing the battery quantity, the UPS should be fully shutdown and the cabinet cover should be removed, and the jumpers on the control board should be re-set as below table:

Battery Number (one series)	JP1 on control board			
	pin1 & pin2	pin3 & pin4	Pin5 & pin6	pin7 & pin8
18	X	X	0	0
19	X	X	1	0
20	X	X	1	1

Note : 1
= insert
with
jumper;

0 = no jumper; x = these pins are for other functions.

NOTE: This operation should be done by professional technicians, please contact the dealer for support.

3-6. Parallel UPS Operation

For parallel UPS operation, please contact your dealer for more professional support.

3-7. LCD Operation

The entire LCD structure is demonstrated as diagram below:

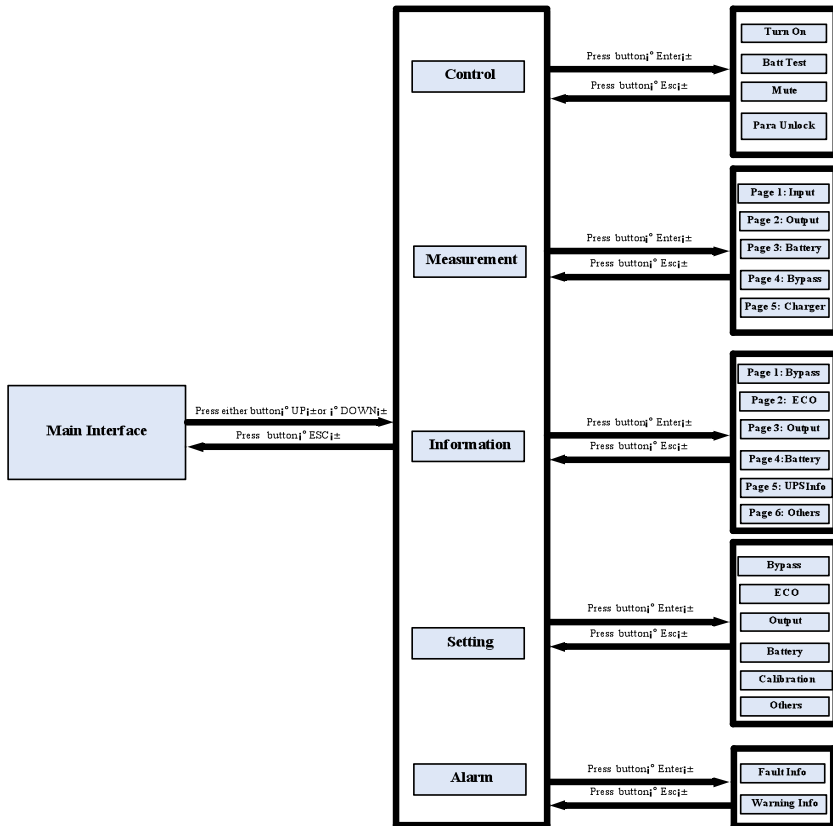

3-7-1. Main interface (home page)

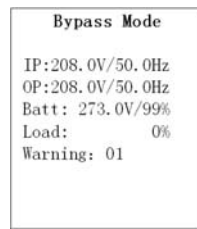
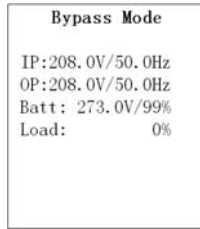

- 1) In the first line, it will display the mode name in different running mode;
- 2) When the alarms happen, the warning or fault information will display below the "load" line;
- 3) When the front panel is not operated for quite a long time, the page will recovery to this home page;
- 4) Press the "UP" or "DOWN" button to enter the main operation menu (see 3-7-2-1);
- 5) When LCD is on this home page, if UPS is in bypass, you could press the "ON/ENTER" button to turn on the UPS to line / converter / ECO / battery mode according to the setting and input status; in reverse, you could press the "OFF/ESC" button to turn off the UPS to bypass mode or shutdown. This has been mentioned on above section of "Single UPS Operation".

3-7-2. Operation menu

3-7-2-1. Main menu

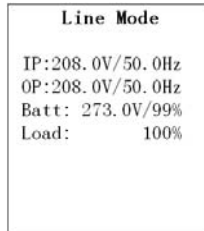

- 1) After pressing the "UP" or "DOWN" button at the home page, the screen will display the main menu of the operation menu. In the main menu, there are 5 items (Control / Measurement / Information / Setting / Alarm) to select.
- 2) Press "UP" or "DOWN" button to select item.
- 3) Press "ON/ENTER" button to confirm the selection.
- 4) Press "OFF/ESC" button to back to home page;
- 5) This operation is same or similar in other menu or page. Please refer to the section of "Button Operation".

3-7-2-2. Control items

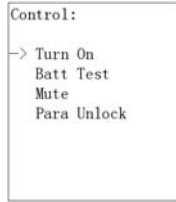

NOTE 1: Usually, all these four items could be seen on this interface except for "Para Unlock". "Para Unlock" appears when and only when parallel communication failure happens.

NOTE 2: "Turn On" will be displayed if UPS is not turned on. "Turn Off" will be displayed if UPS is turned on. In the general situation, these items will not be displayed in the same time or in all operation modes.

1) Turn On/Turn Off

This item is for turning on/off the UPS;

- a) On Bypass mode, it will display "Turn On", if it is selected and confirmed, the UPS will transfer to line mode or converter mode or ECO mode or battery mode according to the setting and input status.

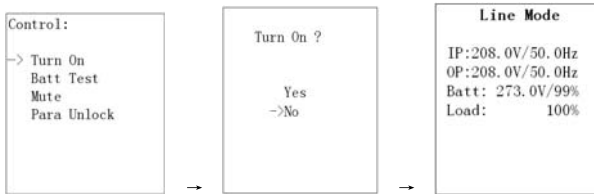

NOTE: You could turn on UPS by pressing "ON/ENTER" button in home page. It's not necessary to enter into this control menu to turn on the UPS.

- b) On line mode or converter mode or ECO mode or battery mode, it will display "Turn Off" in control menu. If it is selected and confirmed, the UPS will transfer to bypass mode or shut down.

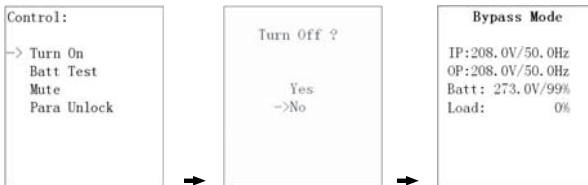

NOTE: You could turn off UPS by pressing "OFF/ESC" button in home page. It is not necessary to enter into this control menu to turn off the UPS.

2) Battery Test

It is to check if the UPS could work well in battery mode and test the battery performance. This item could be shown in all modes but it would not work in Battery/Fault/ECO mode. Related data will be shown at the same time.



3) Mute

This item is to mute the buzzer on battery/bypass/fault mode. In any other modes, this item also could be seen but does not work and related data will be shown meanwhile. After confirm, it will go to the home page and you could see the change of the mute icon.



4) Para Unlock

That means the instruction of "parallel (protection) unlock". It only appears when the LCD shows the warning "3F: Para Protect" (that means the parallel system is in protection and could not startup); if need to startup the UPS, this instruction must be executed.

NOTE: Before executing this instruction, you must check if the system cables and connections are in correct and safe condition. Please read the related content in the section of trouble shooting.

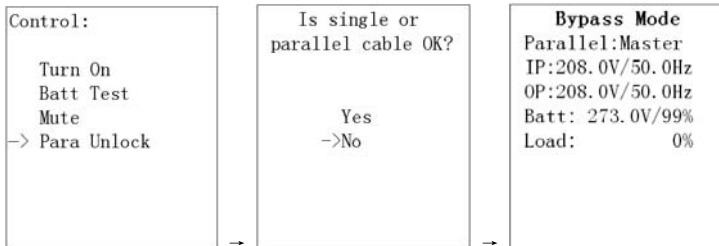

3-7-2-3 Measurement pages

Input: 1/5 Volt: 220.0V Freq: 50.0Hz	Output: 2/5 Volt: 208.0V Curr: 43.3A Freq: 50.0Hz Inv: 208.0V Apparent Power: 10000VA Active Power: 9000W Load: 100%	Battery: 3/5 Volt: 273.0V Cap: 100% Dischg Time: 00:00:00	Bypass: 4/5 Volt: 220.0V Freq: 50.0Hz
Charger: 5/5 Volt: 273.0V Status: On			

These pages display the measurement value of the parameters such as voltage / current / frequency / power / capacity / time etc. Press "UP" or "DOWN" to explore the pages.

3-7-2-4 Information Pages

Bypass: 1/6 Status: Open Enable HighLoss V: 264V LowLoss V: 110V HighLoss F: 54Hz LowLoss F: 46Hz	ECO: 2/6 Status: Open HighLoss V: 232V LowLoss V: 184V HighLoss F: 52Hz LowLoss F: 48Hz	Output: 3/6 Volt: 208V Freq: Auto CVCF: Disable
Battery: 4/6 Backup Time: 990 Minute Batt Test Type: Short Time: 10 Second	UPS Info: 5/6 UPS Model: 10KL DSP Ver: 99-00 MCU Ver: 97-00 Unit Name: XXXXXXXXX Manufacturer: XXXXXXXXX	Others: 6/6 Hot Standby: Disable Bypass Mute: Disable Batt Mute: Disable Fault Mute: Disable

These pages display the information of parameters setting value or status. Press "UP" or "DOWN" to explore the pages.

3-7-2-5. Setting Menu

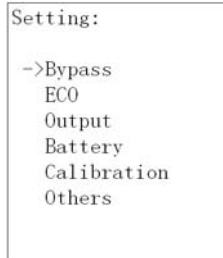

This menu is used to adjust the parameters or do the calibrations.

NOTE: Not all settings could be available in every operation mode. If the setting is not available in present mode, the LCD will show prompt message with "Item can not be set in this mode". Press any button or just wait for several seconds then this message will disappear.

1) Bypass setting

Interface	Description
<div data-bbox="154 751 396 1031" style="border: 1px solid black; padding: 5px;"> Bypass : ->Status: Open Enable HighLoss V: 264V LowLoss V: 110V HighLoss F: 54Hz LowLoss F: 46Hz </div> <div data-bbox="154 1040 396 1315" style="border: 1px solid black; padding: 5px; margin-top: 10px;"> Bypass : ->Status: Forbid HighLoss V: 264V LowLoss V: 110V HighLoss F: 54Hz LowLoss F: 46Hz </div>	<p>1. Status (only available in bypass / line mode)</p> <p>1.1 Open/Forbid: Open: Bypass allowed. When selected, UPS will run at Bypass mode depending on bypass enabled/disabled setting. Forbid: Bypass not allowed. When selected, it's not allowed for running in Bypass mode under any situations.</p> <p>1.2 Enable/Disable This option appears only when "Open/Forbid" is set to "Open". Enable: Bypass enabled. When selected, Bypass mode is activated. Disable: Bypass disabled. When selected, automatic bypass is acceptable, but "manual bypass" is not available. "Manual bypass" means users manually operate UPS to Bypass mode (for example, in Line mode turning off the UPS to Bypass mode). Then, the UPS will go to bypass mode but without output if it is turned off in line mode.</p> <p>NOTE: The following items are only available in bypass mode:</p> <p>2. HighLoss V: Set the acceptable high voltage for bypass. Setting range is from (Rated Output Volt +11V) to 276V and the default value is 264V.</p> <p>3. LowLoss V: Set the acceptable low voltage for bypass. Setting range is from 110V to (Rated Output Volt - 11V) and the default value is 110V.</p> <p>4. HighLoss F: Set the acceptable high frequency for bypass. 50 Hz: Setting range is from 51Hz to 54 Hz. 60 Hz: Setting range is from 61Hz to 64Hz. The default value is 54.0Hz/64.0Hz.</p> <p>5. LowLoss F: Set the acceptable high frequency for bypass. 50 Hz system: Setting range is from 46.0Hz to 49.0Hz. 60 Hz system: Setting range is from 56.0Hz to 59.0Hz. The default value is 46Hz/56Hz.</p>

2) ECO setting (only available or effective on bypass mode)

Interface	Description
<pre>ECO: ->Status: Disable HighLoss V: 232V LowLoss V: 184V HighLoss F: 52Hz LowLoss F: 48Hz</pre>	<ol style="list-style-type: none"> Status Enable: Enable ECO Function Disable: Disable ECO Function If ECO function is disabled, voltage range and frequency range for ECO mode still can be set, but it is meaningless unless the ECO function is enabled. HighLoss V: High voltage point in ECO mode. The setting range is from +5% to +10% of the nominal voltage. LowLoss V: Low voltage point in ECO mode. The setting range is from -5% to -10% of the nominal voltage. HighLoss F: Set low frequency point for ECO mode. 50 Hz system: Setting range is from 46Hz to 48Hz. 60 Hz system: Setting range is from 56Hz to 58Hz. The default value is 48Hz/58Hz. LowLoss F: Set high frequency point for ECO mode. 50 Hz: Setting range is from 52.0Hz to 54.0 Hz. 60 Hz: Setting range is from 62.0Hz to 64.0Hz. The default value is 52.0Hz/62.0Hz.

3) Output setting (only available or effective on bypass mode)

Interface	Description
<pre>Output: ->Volt: 208V Freq: 50Hz CVCF: Enable</pre>	<ol style="list-style-type: none"> Volt: 208: Presenting the rated output voltage with 208Vac 220: Presenting the rated output voltage with 220Vac 230: Presenting the rated output voltage with 230Vac 240: Presenting the rated output voltage with 240Vac Freq: 50Hz: The output frequency is setting for 50Hz. 60Hz: The output frequency is setting for 60Hz. ATO: If selected, output frequency will be decided according to the latest normal utility frequency. If it is from 46Hz to 54Hz, the output frequency will be 50.0Hz. If it is from 56Hz to 64Hz, the output frequency will be 60.0Hz. ATO is default setting. CVCF: To decide whether or not converter mode is activated. Enable: The output frequency will be fixed at 50Hz or 60Hz according to setting of "Freq". The input frequency could be from 46Hz to 64Hz. Disable: The output frequency will synchronize with the input frequency within 46~54 Hz for 50Hz system or within 56~64 Hz for 60Hz system. NOTE: CVCF means Constant Voltage and Constant Frequency, it represents converter mode.

4) Battery setting (available on all operation modes)

Interface	Description
	<ol style="list-style-type: none"> Dischg Protect: 1.1 Enable: Battery discharge protection function is enabled. When UPS have been continuously working in "battery/battery test mode", the UPS will automatically shut down when the running time set by option 1.2 below is up; Disable: Battery discharge protection function is disabled. 1.2

Installation

<pre>Battery: ->DisChg Protect: Enable 990 Minute Batt Test Type: Short Time: Till Batt Low</pre>	<p>000~999: The maximum discharge time ranging from 0 to 999mins. UPS will shut down to protect battery after backup time arrives when the "Dischg Protect" is enabled. If "Dischg protect" is disabled, then this setting does not make sense whatever the setting is; The default value for this setting is 990mins.</p> <p>2. Batt Test Type:</p> <p>2.1 Short Time: Battery test will last for constant 10 seconds;</p> <p>2.2 Long Time: Battery test could last for longer time, which is able to be adjusted within 01~99 minutes.</p> <p>2.3 Till Batt Low: Battery test will not stop until battery voltage is low.</p>
<pre>Battery: ->DisChg Protect: Enable 990 Minute Batt Test Type: Short Time: 10 Minute</pre>	
<pre>Battery: ->DisChg Protect: Enable 990 Minute Batt Test Type: Short Time: 10 Second</pre>	

5) Calibration

Interface	Description
<pre>Calibration: ->Batt: 273.0 +0.0 Inv: 209.0 +0.0 Chg: 273.0 +0.0</pre>	<ol style="list-style-type: none"> Batt: Calibrate the battery voltage measurement; the calibration range is from 0V to 5.7V, the default value is 0V. It is available on all operation modes. Inv: Adjust the inverter output voltage; the adjustable range is from 0V to 6.4V, the default value is 0V. It is only available in line / battery / converter mode; Chg: Adjust the Charger output voltage; the adjustable value is from 0V to 6.9V, the default value is 0V. It is only available in bypass / line / ECO /converter mode. (NOTE: Before making charger output voltage adjustment, be sure to disconnect all batteries first to get the accurate charger voltage; Be careful that the adjustment should be suitable to battery specifications, or the battery maybe destroyed.)

6) Other settings (available on all operation modes)

Interface	Description
<div style="border: 1px solid black; padding: 5px; margin-bottom: 10px;"> <p>Others:</p> <p>->Hot Standby Backup Time</p> </div> <p style="text-align: center; color: purple;">↓</p> <div style="border: 1px solid black; padding: 5px;"> <p>Hot Standby:</p> <p>->Status: Disable</p> </div>	<p>Hot standby: Enable: Hot standby function is enabled. It means that the current UPS is set to be host of hot standby system, and it will automatically restart after AC recovery even without battery connected. Disable: Hot standby function is disabled. The UPS is running at normal mode and can't restart without battery. Disable is default setting.</p>

<div style="border: 1px solid black; padding: 5px; margin-bottom: 10px;"> <p>Others:</p> <p>Hot Standby ->Backup Time</p> </div> <p style="text-align: center; color: purple;">↓</p>	<p>Backup Time Parameters Setting: This function is only available for UPS with isolation transformer. Batt Groups: Set the number of battery group ranging from 1 to 6. The default value is 1 group; Batt Cap: Set the battery capacity such as 7AH, 9AH, 10AH, 12AH, 17AH, 26AH, 40AH, 65AH, 100AH and so on. The default value is 9AH. Factor: Calibrate the displayed backup time by adjusting this multiplier factor. The formulation is listed below: Displayed backup time=Original calculated backup time×Multiplier factor The value of default factor is 1.0, and it ranges from 0.5 to 2. These parameters are for the battery backup time calculation</p>
---	---

Backup Time: ->Batt Groups: 1 Batt Cap: 9AH Factor: 1.0	
--	--

3-7-2-6. Alarm page

```
Alarm Info  
Fault:  
14:Output Short  
Warning:  
01:Bat Open
```

This page record and display the faults or warnings event happened in history.

4. Trouble Shooting

4-1. Warning status

When Fault LED flashes and the buzzer beeps once every second, it means that there are some problems with UPS. Users can see the warning code from LCD panel and refer to the trouble shooting table to check what problem probably happen.

4-2. Fault mode

- 1) When Fault LED illuminates and the buzzer beeps continuously, it means that there is a fatal error about UPS. Users can get the fault code from LCD panel. Please refer to the trouble shooting table to check what problems probably happen.
- 2) Don't try to turn on the UPS again before the problem is clear. If the problems can't be fixed, please contact the distributor or service people immediately.
- 3) For emergency case, please cut off the connection from utility, external battery, and output immediately to avoid more risk or danger.

4-3. Trouble shooting table

If the UPS system does not operate correctly, please solve the problem by referring to the table below:

Alarm type	LCD display	Possible cause	Remedy
Warning	01: Batt Open	<ol style="list-style-type: none"> 1) The battery is not connected well; 2) The battery protection device is open. 	<ol style="list-style-type: none"> 1) Connect the battery well; 2) Replace or restore the protection device.
Warning	07: Over Charge	<ol style="list-style-type: none"> 1) Battery numbers and its setting is not matching; 2) Charger voltage is too high, the charger failed. 	<ol style="list-style-type: none"> 1) Correct the battery number or its setting; 2) Disconnect the battery and check the charger output voltage, contact the dealer for repair.
Warning	08: Batt Low	<ol style="list-style-type: none"> 1) Battery is discharged deeply to low voltage; 2) Battery number is not correct; 3) Battery is in the end of life. 	<ol style="list-style-type: none"> 1) Recharge the battery; 2) Correct the battery number; 3) Replace the battery.
Warning	09: Over load	The load is too heavy.	Remove excess loads from UPS output.
Warning	0A: Fan Error	<ol style="list-style-type: none"> 1) Fan is blocked; 2) Fan is in the end of life; 3) Fan detection circuit failed. 	<ol style="list-style-type: none"> 1) Make the fan not blocked; 2) Contact the dealer for replacing the fan; 3) Contact the dealer for repair.
Warning	0B: EPO Enable	EPO plug (jumper) is removed or the external EPO switch is off.	Connect the EPO plug (jumper) well or switch on the external EPO switch.
Warning	0D: Over Temp	<p>The internal temperature is too high and reach the warning level:</p> <ol style="list-style-type: none"> 1) Maybe the environment is hot; 2) Maybe the fan is blocked or failed; 3) Maybe the ventilate is blocked by the wall or other goods; 4) Load is too heavy. 	<ol style="list-style-type: none"> 1) Make sure the ambient temperature not over 40° C; 2) Make sure the fan is OK; 3) Make sure the ventilate is well; 4) Remove some loads if possible.
Warning	0E: Charger Fail	Charger failed.	Contact the dealer for repair.

Trouble Shooting / Storage

Fault	14: Output Short	Short circuit occurs on the UPS output.	Remove the short circuit.
Fault	1A: NegPower	UPS output power is negative. It means there is energy feedback into the internal of UPS from output. It may be caused by regenerative load; or caused by the current control failure in the parallel system.	Contact the dealer.
Fault	21: Batt SCR Short	The internal battery SCR is failed and short.	Contact the dealer for repair.
Fault	24: Inv Rly Short	The internal inverter relay is stick to short or the SCR of STS (Static Transfer Switch) is short.	Contact the dealer for repair.
Fault	35: Para Comm Fail	Parallel cable for communication is not connected well in the parallel system.	Connect the parallel cable well.
Fault	36: OP.I Unbalance	The output current is extremely unbalanced between the paralleled UPSs, there is some error in the parallel system.	Contact the dealer for repair.
Fault	41: Over Temp	The internal temperature is too high and reach the fault level (shutdown): 1) Maybe the environment is hot; 2) Maybe the fan is blocked or failed; 3) Maybe the ventilate is blocked by the wall or other goods; 4) Load is too heavy.	1) Make sure the ambient temperature not over 40°C; 2) Make sure the fan is OK; 3) Make sure the ventilate is well; 4) Remove some loads if possible.
Fault	42: CPU Comm Fail	Internal communication between the CPUs failed	Contact the dealer for repair.
Fault	43: Over load	Overload time is out of the specification and the UPS shut down automatically.	Remove excess loads from UPS output and restart it.

5. Storage

Before storing, charge the UPS at least 7 hours. Store the UPS covered and upright in a cool, dry location. During storage, recharge the battery in accordance with the following table:

Storage Temperature	Recharge Frequency	Charging Duration
-25°C - 40°C	Every 3 months	1-2 hours
40°C - 45°C	Every 2 months	1-2 hours

MODEL		6KRT-ISO	10KRT-ISO
CAPACITY*		6000 VA / 5400 W	10000 VA / 9000 W
INPUT			
Voltage Range	Low Line Loss	110 VAC \pm 3 % at 50% Load; 176 VAC \pm 3 % at 100% Load	
	Low Line Comeback	Low Line Loss Voltage + 10V	
	High Line Loss	300 VAC \pm 3 %	
	High Line Comeback	High Line Loss Voltage - 10V	
Frequency Range		46Hz ~ 54 Hz @ 50Hz system 56Hz ~ 64 Hz @ 60Hz system	
Phase		Single phase with ground	
Power Factor		\geq 0.99 at 100% Load	
OUTPUT			
Output voltage		100/104/110/115/120/200V/208/220/230/240VAC	
AC Voltage Regulation		\pm 3%	
Frequency Range (Synchronized Range)		46Hz ~ 54 Hz @ 50Hz system 56Hz ~ 64 Hz @ 60Hz system	
Frequency Range (Battery Mode)		50 Hz \pm 0.1 Hz or 60Hz \pm 0.1 Hz	
Overload	Line mode	100%~105%: 10min; 105%~115%: 1min; >115% : 1sec	
	Battery mode	100%~105%: 30sec; 105%~115%: 10sec; >115% : 1sec	
Current Crest Ratio		3:1 max	
Harmonic Distortion		\leq 3.5 % @ 100% Linear Load; \leq 7 % @ 100% Non-linear Load	
Transfer Time	Line \leftrightarrow Battery	0 ms	
	Inverter \leftrightarrow Bypass	0 ms	
	Inverter \leftrightarrow ECO	<10 ms	
EFFICIENCY			
Line mode		> 84%	
Battery Mode		> 82%	
BATTERY			
Standard Model	Type & Numbers	12 V / 7 Ah x 20	12 V / 9 Ah x 20
	Recharge Time	7 hours recover to 90% capacity	9 hours recover to 90% capacity
	Charging Current	1A \pm 10% (max.)	
	Charging Voltage	13.65 V \pm 1%	
Long Run Model	Type	Depending on applications	
	Numbers**	18 ~ 20	
	Charging Current	4 A \pm 10% (max.)	
	Charging Voltage	13.65 V \pm 1%	
PHYSICAL			
Dimension,DXWXH(mm)	UPS unit: 580X438 X133 Battery pack: 580X438 X133 ISO BANK: 580 X 438 X 133	UPS unit: 668X438 X133 Battery pack: 580X438 X133 ISO BANK: 668 X 438 X 133	
Net Weight (kgs)	UPS unit: 20 Battery pack: 57 ISO BANK: 67	UPS unit: 23.5 Battery pack: 63 ISO BANK: 90	
ENVIRONMENT			
Operation Temperature		0 ~ 40°C (the battery life will down when > 25°C)	
Operation Humidity		<95 % and non-condensing	
Operation Altitude***		<1000m	
Acoustic Noise Level		Less than 58dB @ 1 Meter	Less than 60dB @ 1 Meter
MANAGEMENT			
Smart RS-232 or USB		Supports Windows® 2000/2003/XP/Vista/2008, Windows® 7, Linux, Unix, and MAC	
Optional SNMP		Power management from SNMP manager and web browser	

* If the UPS is in converter mode, the power capacity will be derated to 60% of full capacity;

**If the battery number is 18, the power capacity will be derated to 90%; if it is 19, the power capacity will be derated to 95%;

***If the UPS is installed or used in a place where the altitude is above than 1000m, the output power must be derated one percent per 100m.

■Product specifications are subject to change without further notice.

Enter this link to register your product.



Bolivia: 800-100156

Colombia: 01800-5181617

Costa Rica: 800-435737

El Salvador: 800-6773

Honduras: 800-25616099

México: 001800 514 8611

Panamá: 011-00800-2268611

Perú: 0800-54674

República Dominicana: 1888-7514876

Venezuela: 0800-1627485